



SHOCKER HITCH

AIR RIDE TOWING HITCHES

SAFER. SMOOTHER. EVERY MILE.



WHERE IT ALL BEGAN...

The Shocker Hitch story began with Bob Sagen's decades of experience in the racing industry, where he spent 30 years towing trailers across thousands of miles. In 1990, after finding that his heavy-duty service truck's stiff suspension was consistently cracking the welds on his trailer tongues, Sagen engineered a creative solution: a custom pivot hitch utilizing a coil spring. This prototype immediately stopped the structural damage and provided a significantly smoother ride, serving him faithfully until he eventually retired the truck.

In 2000, Sagen pivoted from building race cars to manufacturing trailers under his new company, Travel-Lite. Realizing that the "jerky" towing experience was a universal frustration for his customers. He returned to his shock absorbing hitch and spent three years refining his original design for the modern market. By replacing the static coil spring with an adjustable air bag, he created a versatile system that could be fine-tuned for any load. This innovation eliminated the bounce and tug of traditional towing, officially launching the Shocker Hitch as the industry standard for air-ride towing comfort.

Today our mission is to make towing **"Safer, Smoother, Every Mile"**

WE BUILD IT LIKE SOMEONE WE LOVE IS TOWING WITH IT



ADVANTAGES OF AIR RIDE HITCHES

For smooth towing and controlling road shock, jerks, pulls, pushes and sways, air ride hitches are number one. Any air spring bag is simply the best shock absorbing and cushioning device on the planet.

SAFER SMOOTHER TOWING EVERY MILE

It improves the ride and makes towing a trailer smoother. It's easier on you and your equipment, plus it reduces wear and tear on the pickup and trailer. Built-in air ride system offers a smoother towing experience. It filters and absorbs road shock, tugs, jerks, bumps, bangs, and sways, creating a smooth ride. It directs the normal towing resistance between the tow vehicle and trailer through the air ride system, which produces a much smoother ride. It also naturally reduces trailer sway by filtering and absorbing the changing tongue weight that occurs when towing on uneven roads. Smoother makes it safer.

REDUCES STRESS, BREAKAGE, WEAR & TEAR ON TRUCK, TRAILER, CARGO & EQUIPMENT

An air ride hitch reduces wear and tear on the driveline and frame. Less stress means less wear and tear on both the tow vehicle and the trailer frame and welds. It's a must have for newer trailers with aluminum frames that tend to crack because of rough roads and a traditional hard truck to trailer connection. An air ride hitch will greatly reduce the chances of frame cracking and breaking.

PROVIDES COMFORT & IMPROVE CONTROL TOWING

The smoother towing you get makes it easier on you, your passengers, animals, cargo and trailer. The air ride design filters the natural tugs between the trailer and pickup giving you more control and comfort when towing a trailer. By giving you improved control of your tow vehicle and trailer, it is safer. The air ride hitch system allows for better control of your pickup and the trailer it is towing.

EASILY ADJUSTABLE FOR TOW WEIGHT

Air ride is built into the receiver hitch, gooseneck coupler, tongue mount or 5th wheel camper pin box. They use a greaseable hardened steel pivot bolt. The jerks, tugs and sways are filtered, absorbed and dampened by pushing them into the air spring bag. You can easily fine-tune and adjust the air pressure for best ride and load control on every trip. For heavier loads, increase the air pressure; for lighter loads reduce it. A cushion, steel spring or torsion hitch is not adjustable for tow weight or tongue weight.

REDUCES STRESS ON PASSENGERS & ANIMALS

Passengers, horses, livestock and other animals experience less stress while being towed. The shock dampening design effectively absorbs the jerking, tugging, bumps and damaging forces experienced when towing on rough roads and concrete highways, which you would normally feel with a typical hard connection. This makes the ride smoother and less stressful inside the tow vehicle and inside the trailer.

IMPROVED FUEL ECONOMY

Customers using air hitches report improved gas mileage of 1 to 2 miles per gallon because the tow vehicles and trailer work together better with less friction, which reduces downshifting and improves overall performance.

SAVES MONEY

Save money with less breakage and improved fuel mileage. Trailer coupler, a-frames along with all the welds on steel or aluminum can be very expensive to fix. Plus if they break while towing a trailer, very dangerous. An air ride hitch or coupler can reduce the chances of breakage, which can save you a great deal of money.

INSTALLS IN MINUTES

An air hitch for receiver, 5th wheel or gooseneck literally installs in minutes. You can add air ride towing to your setup quickly. An air receiver hitch takes about 2 minutes. The gooseneck air hitch and coupler takes about 5 minutes. The quick air 5th wheel to gooseneck conversion kit and the 5th wheel air ride pin box take about 10 minutes to install.

TABLE OF CONTENTS

RECEIVER HITCHES 05

- Shocker 14K Air Receiver Hitch 06
- Shocker 20K HD Air Receiver Hitch 07-08
- Speciality Air Receiver Hitches 09
- Impact™ Cushion Receiver Hitches 10
- XR Adjustable Receiver Hitches 11
- Ball Mount Attachments 12
- Pintle Hook & Farm Attachments/Kits 13
- Sway Control Attachments 14
- Sway Control Towing Accessories 15
- Miscellaneous Hitch Accessories 16
- Air Equalizer For Weight Distribution 17

GOOSENECK HITCHES 18

- 30K Gooseneck Surge® Air Hitch & Coupler 19
- 30K Gooseneck Surge® Air Hitch & Offset Coupler 20
- Speciality Gooseneck Surge® Air Hitches 21
- Gooseneck Replacement Couplers 22-24
- Gooseneck Outer Sleeves 24

5TH WHEEL HITCHES 25

- Quick Air® 5th Wheel to Gooseneck Kits 26
- 5th Wheel to Gooseneck Conversion Kits 27
- Quick Air® 5th Wheel Air Ride Pin Box 28

TONGUE MOUNTS 29

- Air Ride Trailer Tongue Mounts 30
- Trailer Mount Channels & More! 31
- Trailer Couplers & Pintle Ring 32

ACCESSORIES & PARTS 33

- Auto Air Compressor Kit 33
- Skid Steer Trailer Mover 33
- Hitch Locks 34
- Replacement Parts 35



RECEIVER HITCHES

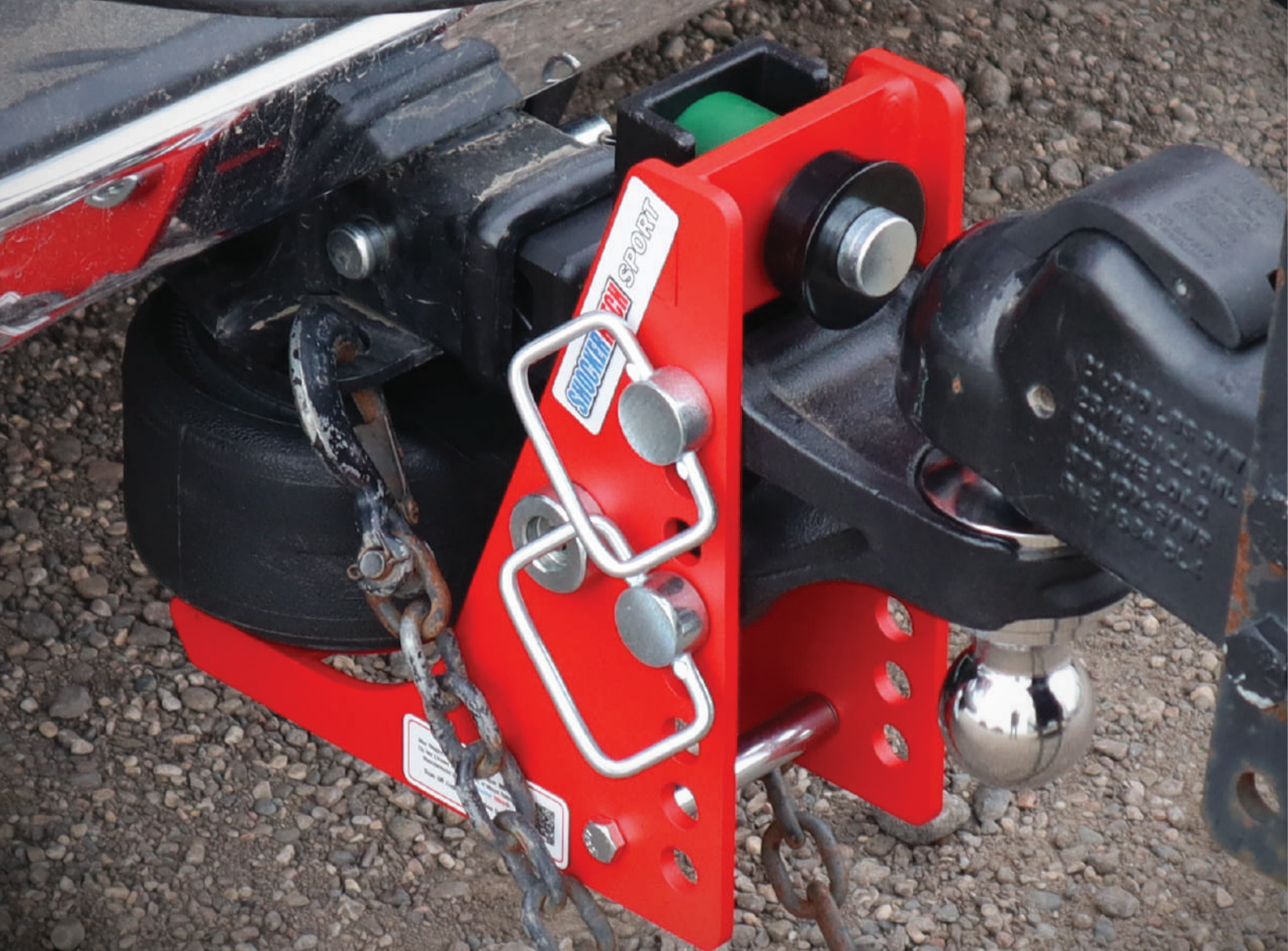

- ✓ **ADJUSTABLE FOR TOW WEIGHT**
- ✓ **SAVES EQUIPMENT & CARGO**
- ✓ **REDUCES TRAILER SWAY**
- ✓ **REDUCES BREAKAGE**

Shocker 14K Air Receiver Hitch



Install Time: 2 minutes 20+ Ball Mount Options (see pages 12-16) HOT SELLERS

ADJUSTABLE FOR TOW WEIGHT SAVES EQUIPMENT & CARGO REDUCES TRAILER SWAY REDUCES BREAKAGE



14K AIR RECEIVER HITCH 14,000 lbs. GTW / 1,400 lbs. TW

SH-200-200	2" SHANK	BASE FRAME	
SH-200-250	2-1/2" SHANK	BASE FRAME	
SH-620-200C	2" SHANK	w/CHROME COMBO BALL	
SH-620-250C	2-1/2" SHANK	w/CHROME COMBO BALL	



14K MAX AIR RECEIVER HITCH 14,000 lbs. GTW / 1,400 lbs. TW

SH-MB200-200	2" SHANK	BASE FRAME	
SH-MB200-250	2-1/2" SHANK	BASE FRAME	
SH-MB620-200BLK	2" SHANK	w/BLACK COMBO BALL	
SH-MB620-250BLK	2-1/2" SHANK	w/BLACK COMBO BALL	



Shocker 20K HD Air Receiver Hitch



Install Time: 2 minutes 20+ Ball Mount Options (see pages 12-16) HOT SELLERS

ADJUSTABLE FOR TOW WEIGHT SAVES EQUIPMENT & CARGO REDUCES TRAILER SWAY HEAVY DUTY BUILD



20K AIR RECEIVER HITCH 20,000 lbs. GTW / 2,000 lbs. TW

SH-HD200-200	2" SHANK	BASE FRAME
SH-HD200-250	2-1/2" SHANK	BASE FRAME
SH-HD200-300	3" SHANK	BASE FRAME
SH-HD620-200C	2" SHANK	w/CHROME COMBO BALL
SH-HD620-250C	2-1/2" SHANK	w/CHROME COMBO BALL



20K MAX AIR RECEIVER HITCH 20,000 lbs. GTW / 2,000 lbs. TW

SH-HDMB200-200	2" SHANK	BASE FRAME
SH-HDMB200-250	2-1/2" SHANK	BASE FRAME
SH-HDMB200-300	3" SHANK	BASE FRAME
SH-HDMB620-200BLK	2" SHANK	w/BLACK COMBO BALL
SH-HDMB620-250BLK	2-1/2" SHANK	w/BLACK COMBO BALL



Shocker 20K HD Air Receiver Hitch



Install Time: 2 minutes 20+ Ball Mount Options (see pages 12-16) HOT SELLERS

ADJUSTABLE FOR TOW WEIGHT SAVES EQUIPMENT & CARGO REDUCES TRAILER SWAY HEAVY DUTY BUILD



20K SUPER DROP AIR RECEIVER HITCH 20,000 lbs. GTW / 2,000 lbs. TW

12 ADJUSTMENT HOLES - MINIMUM OF 22" FROM GROUND TO BOTTOM OF RECEIVER

SH-HDMB200-200-12	2" SHANK	BASE FRAME	
SH-HDMB200-250-12	2-1/2" SHANK	BASE FRAME	
SH-HDMB200-300-12	3" SHANK	BASE FRAME	
SH-HDMB640-200-12-25	2" SHANK	w/DROP BALL - 2-5/16"	
SH-HDMB640-250-12-25	2-1/2" SHANK	w/DROP BALL - 2-5/16"	



20K MEAN GREEN AIR RECEIVER HITCH 20,000 lbs. GTW / 2,000 lbs. TW

SH-HDG200-200	2" SHANK	BASE FRAME	
SH-HDG200-250	2-1/2" SHANK	BASE FRAME	
SH-HDG200-300	3" SHANK	BASE FRAME	
SH-HDG620-200C	2" SHANK	w/CHROME COMBO BALL	
SH-HDG620-250C	2-1/2" SHANK	w/CHROME COMBO BALL	



Speciality Air Receiver Hitches



Install Time: 2 minutes 20+ Ball Mount Options (see pages 12-16) HOT SELLERS

ADJUSTABLE FOR TOW WEIGHT SAVES EQUIPMENT & CARGO REDUCES TRAILER SWAY REDUCES BREAKAGE



8K SPORT™ AIR RECEIVER HITCH

8,000 lbs. GTW / 800 lbs. TW

SH-S200-200	2" SHANK	BASE FRAME
SH-S620-200C	2" SHANK	w/CHROME COMBO BALL
SH-S620-200BLK	2" SHANK	w/BLACK COMBO BALL

ECONOMY BUILD WITH THE SAME GREAT AIR RIDE COMFORT



TRAILFORCE® AIR RECEIVER HITCH

14,000 lbs. GTW / 1,400 lbs. TW

SH-TF200-200	2" SHANK	BASE FRAME
SH-TF620-200C	2" SHANK	w/CHROME COMBO BALL
SH-TF620-200BLK	2" SHANK	w/BLACK COMBO BALL

•GREAT FOR SUVs, FLATBED & SERVICE BODY TRUCKS, WHERE THE RECEIVER HITCH IS INSIDE THE BUMPER
•PATENT PENDING DESIGN



10K STREAMLINE ALUMINUM AIR RECEIVER HITCH

- 10,000 lbs. GTW / 1,000 lbs. TW

SH-500-200	2" SHANK	BASE FRAME
SH-520-200C	2" SHANK	w/CHROME COMBO BALL
SH-520-200BLK	2" SHANK	w/BLACK COMBO BALL

•ALUMINUM FRAME, SHANK, AND AIR BAG PADDLE - HALF THE WEIGHT OF HD HITCH
•PATENT PENDING DESIGN



Impact™ Cushion Receiver Hitches

🔧 *Install Time: 2 minutes*

🔩 *20+ Ball Mount Options (see pages 12-16)*

🔥 *HOT SELLERS*

✔️ *DUAL CUSHION ABSORPTION*

✔️ *SAVES EQUIPMENT & CARGO*

✔️ *REDUCES TRAILER SWAY*

✔️ *REDUCES BREAKAGE*



14K IMPACT™ CUSHION RECEIVER HITCH 14,000 lbs. GTW / 1,400 lbs. TW

SH-100	2" SHANK	BASE FRAME	
SH-125	2-1/2" SHANK	BASE FRAME	
SH-100-340C	2" SHANK	w/CHROME COMBO BALL	🔥
SH-125-340C	2-1/2" SHANK	w/CHROME COMBO BALL	🔥
SH-100-333	2" SHANK	w/CHANNEL PINTLE HOOK	🔥
SH-125-333	2-1/2" SHANK	w/CHANNEL PINTLE HOOK	🔥



20K IMPACT™ MAX CUSHION RECEIVER HITCH 20,000 lbs. GTW / 2,000 lbs. TW

SH-C100	2" SHANK	BASE FRAME	
SH-C125	2-1/2" SHANK	BASE FRAME	
SH-C130	3" SHANK	BASE FRAME	
SH-C100-340BLK	2" SHANK	w/BLACK COMBO BALL	🔥
SH-C125-340BLK	2-1/2" SHANK	w/BLACK COMBO BALL	🔥
SH-C100-333	2" SHANK	w/CHANNEL PINTLE HOOK	🔥
SH-C125-333	2-1/2" SHANK	w/CHANNEL PINTLE HOOK	🔥
SH-C125-334-25	2-1/2" SHANK	w/PINTLE & BALL (2-5/16")	🔥



CAN BE FLIPPED FOR MORE RISE & DROP



XR Adjustable Receiver Hitches

 **Install Time: 2 minutes**  **20+ Ball Mount Options (see pages 12-16)**  **HOT SELLERS**







 **HEIGHT ADJUSTABLE**

 **QUICK & EASY USE**

 **GREAT FOR CONTRACTORS & FARMERS**



8-CHANNEL XR ADJUSTABLE RECEIVER HITCH WEIGHT RATING BASED ON SHANK SIZE







SH-XR100	2" SHANK	BASE FRAME	
SH-XR125	2-1/2" SHANK	BASE FRAME	
SH-XR100-340C	2" SHANK	w/CHROME COMBO BALL	
SH-XR125-340C	2-1/2" SHANK	w/CHROME COMBO BALL	
SH-XR100-333	2" SHANK	w/CHANNEL PINTLE HOOK	
SH-XR125-333	2-1/2" SHANK	w/CHANNEL PINTLE HOOK	
SH-XR100-334-25	2" SHANK	w/CHANNEL PINTLE & BALL (2-5/16" BALL)	
SH-XR125-334-25	2-1/2" SHANK	w/CHANNEL PINTLE & BALL (2-5/16" BALL)	

WEIGHT CAPACITY

•2" SHANK - 12,000 lbs. GTW / 1,200 lbs. TW
 •2-1/2" SHANK - 16,000 lbs. GTW / 1,600 lbs. TW
 •3" SHANK - 20,000 lbs. GTW / 2,000 lbs. TW



10-CHANNEL XR ADJUSTABLE RECEIVER HITCH WEIGHT RATING BASED ON SHANK SIZE

SH-XR100-10	2" SHANK	BASE FRAME	
SH-XR125-10	2-1/2" SHANK	BASE FRAME	
SH-XR130	3" SHANK	BASE FRAME	
SH-XR100-10-340C	2" SHANK	w/CHROME COMBO BALL	
SH-XR125-10-340C	2-1/2" SHANK	w/CHROME COMBO BALL	
SH-XR100-10-333	2" SHANK	w/CHANNEL PINTLE HOOK	
SH-XR125-10-333	2-1/2" SHANK	w/CHANNEL PINTLE HOOK	
SH-XR100-10-334-25	2" SHANK	w/CHANNEL PINTLE & BALL (2-5/16" BALL)	
SH-XR125-10-334-25	2-1/2" SHANK	w/CHANNEL PINTLE & BALL (2-5/16" BALL)	

CAN BE FLIPPED FOR MORE RISE & DROP

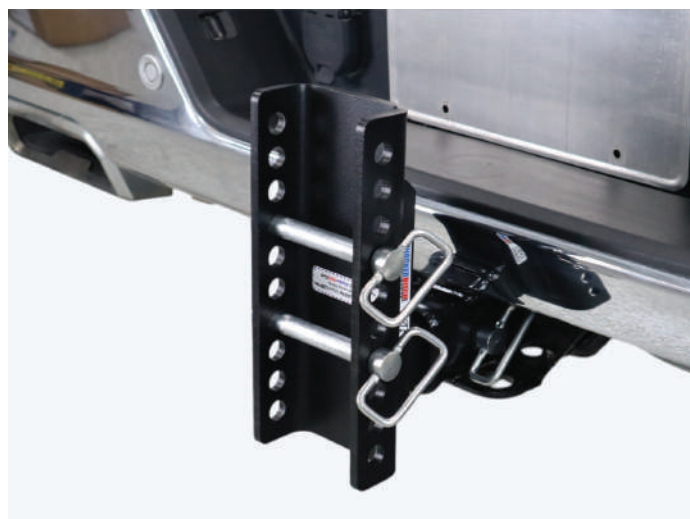



Ball Mount Attachments



SHOCKER COMBO BALL MOUNT **COMES WITH 2" AND 2-5/16" BALLS**

SH-340C

CHROME COMBO BALL

SH-340BLK

BLACK COMBO BALL

SH-340RED

RED COMBO BALL

*2" RATED 10,000 lbs. GTW / 1,000 lbs. TW
2-5/16" RATED 20,000 lbs. GTW / 2,000 lbs. TW*



SHOCKER RAISED BALL MOUNT **COMES WITH 2" OR 2-5/16" BALLS**

SH-310125

w/NO BALL

SH-310125-2

w/2" BALL

SH-310125-25

w/2-5/16" BALL

*2" RATED 10,000 lbs. GTW / 1,000 lbs. TW
2-5/16" RATED 20,000 lbs. GTW / 2,000 lbs. TW*



SHOCKER DROP BALL MOUNT **COMES WITH 2" OR 2-5/16" BALLS**

SH-320125

w/NO BALL

SH-320125-2

w/2" BALL

SH-320125-25

w/2-5/16" BALL

*2" RATED 10,000 lbs. GTW / 1,000 lbs. TW
2-5/16" RATED 20,000 lbs. GTW / 2,000 lbs. TW*

Pintle Hook & Farm Attachments



SHOCKER PINTLE HOOK
10-Ton / 20,000 lbs. GTW

SH-333



SHOCKER RAISED PINTLE HOOK
10-Ton / 20,000 lbs. GTW

SH-335



SHOCKER PINTLE HOOK & BALL
8-Ton / 16,000 lbs. GTW

SH-334-2

w/2" BALL

SH-334-25

w/2-5/16" BALL



SHOCKER DRAW BAR
20,000 lbs. GTW / 0 lbs. TW

SH-350



SHOCKER CUSHIONED DRAW BAR
20,000 lbs. GTW / 0 lbs. TW

SH-370



SHOCKER CLEVIS PIN
20,000 lbs. GTW / 2,000 lbs. TW

SH-360



Farm Attachment Towing Kits



COMBO FARM MOUNT KIT



SH-FTK-C

w/CHROME
COMBO BALL

SH-FTK-BLK

w/BLACK COMBO
BALL

SH-FTK-RED

w/RED COMBO
BALL

DELUXE COMBO FARM MOUNT KIT



SH-FTK2-C

w/CHROME
COMBO BALL

SH-FTK2-BLK

w/BLACK COMBO
BALL

SH-FTK2-RED

w/RED COMBO
BALL



Sway Control Attachments



SHOCKER SWAY TAB COMBO BALL MOUNT **COMES WITH 2" AND 2-5/16" BALLS**

SH-340C-SC CHROME COMBO BALL

SH-340BLK-SC BLACK COMBO BALL

SH-340RED-SC RED COMBO BALL

*2" RATED 10,000 lbs. GTW / 1,000 lbs. TW
2-5/16" RATED 20,000 lbs. GTW / 2,000 lbs. TW*

Also works with SH-1001 Shocker Sway Control Friction Arm Bar & Ball Kit



SHOCKER SWAY TAB RAISED BALL MOUNT **COMES WITH 2" OR 2-5/16" BALLS**

SH-310125SC w/NO BALL

SH-310125-2SC w/2" BALL

SH-310125-25SC w/2-5/16" BALL

*2" RATED 10,000 lbs. GTW / 1,000 lbs. TW
2-5/16" RATED 20,000 lbs. GTW / 2,000 lbs. TW*

Also works with SH-1001 Shocker Sway Control Friction Arm Bar & Ball Kit



SHOCKER SWAY TAB DROP BALL MOUNT **COMES WITH 2" OR 2-5/16" BALLS**

SH-320125SC w/NO BALL

SH-320125-2SC w/2" BALL

SH-320125-25SC w/2-5/16" BALL

*2" RATED 10,000 lbs. GTW / 1,000 lbs. TW
2-5/16" RATED 20,000 lbs. GTW / 2,000 lbs. TW*

Also works with SH-1001 Shocker Sway Control Friction Arm Bar & Ball Kit

Sway Control Accessories



SHOCKER SWAY CONTROL FRICTION ARM BAR & BALL KIT

SH-1001

1 SWAY ARM KIT

SH-1001-X2

2 SWAY ARM KITS

- Minimizes swaying caused by wind, passing trucks, and more
- Reversible arm works on either the driver or passenger side
- Use one kit for under 10,000 lbs. & two kits for over 10,000 lbs.
- Includes friction bar assembly, two 1-1/4" mini balls, and hardware



SHOCKER CLAMP ON TRAILER FRAME MOUNT BRACKET KIT FOR SWAY CONTROL FRICTION ARM BAR

SH-7010

COMPLETE KIT

- Clamps securely around the trailer frame to avoid drilling
- Perfect for aluminum trailers - designed to fit trailer frame rails from 4" to 8" tall A-frames
- Made of 6061-T6 aluminum with textured matte black powder coat
- Includes all stainless steel mounting hardware for durability
- Works with Shocker SH-1001 friction sway arm kits and most similar systems

Miscellaneous Hitch Accessories



SHOCKER 2" RECEIVER HITCH ADAPTER MOUNT

SH-405

- Fits Shocker Air, Streamline, HD, Impact, and XR hitches
- Perfect for mounting 2" hitch accessories like bike racks, cargo baskets, and steps
- Supports up to 5,000 lbs. GTW and 300 lbs. TW



SHOCKER HITCH SHACKLE - FITS RECEIVER HITCHES

SH-380

- Perfect for securing tow straps, winches, and cable ratchets
- Rated for a 5-ton (10,000 lbs) maximum load capacity
- Fits Shocker Air, Streamline, HD, Impact, and XR hitches
- Provides a secure anchor point while your trailer is hooked-up



SHOCKER ANTI-RATTLE HITCH STABILIZER KIT

SH-770

- Fits 2" Impact & XR series ONLY (will not work with Air series)
- Eliminates hitch rattle and shank movement for a noise-free ride
- Minimizes metal-on-metal wear on your hitch and receiver tube
- Bolts on in minutes with included hardware

Air Equalizer For Weight Distribution

 **Install Time: 15 minutes (Made for trucks - will NOT work with SUVs)**

 **BOLT-ON INSTANT AIR RIDE**

 **SAVES CAMPER & CONTENTS**

 **REDUCES TRAILER SWAY**

 **REDUCES BREAKAGE**



SHOCKER AIR RIDE EQUALIZER 12,000 lbs. GTW / 1,200 lbs. TW

SH-7002	2" SHANK - 5" RISE 2" DROP
SH-7002-10	2" SHANK - 5" RISE 4" DROP
SH-7025	2-1/2" SHANK - 5" RISE 2" DROP
SH-7025-10	2-1/2" SHANK - 5" RISE 4" DROP
SH-7003	3" SHANK - 5" RISE 4" DROP

FITS & BOLTS TO SHOCKER WD HITCHES & TO MOST MAJOR BRANDS OF WEIGHT-DISTRIBUTION HITCH HEADS: FASTWAY E2, EQUALIZER, REESE, HUSKY, PRO SERIES, TORKLIFT, BLUE OX, CAMCO EAZ LIFT & CURT ROUND BAR, CURT TRUTRACK & TRUNNION HEAD



SHOCKER AIR EQUALIZER & ROUND BAR WD HITCH 12,000 lbs. GTW / 1,200 lbs. TW

SH-7002/SH-7600	2" SHANK - 5" RISE 2" DROP
SH-7002-10/SH-7600	2" SHANK - 5" RISE 4" DROP
SH-7025/SH-7600	2-1/2" SHANK - 5" RISE 2" DROP
SH-7025-10/SH-7600	2-1/2" SHANK - 5" RISE 4" DROP
SH-7003/SH-7600	3" SHANK - 5" RISE 4" DROP

WANT SWAY CONTROL? ADD PART# SH-1001 (SHOCKER FRICTION SWAY ARMS)

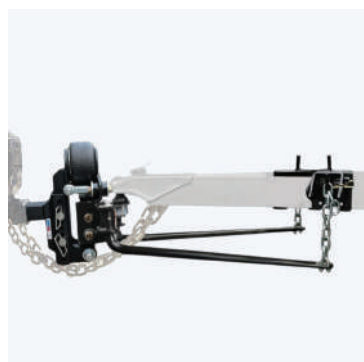

SHOCKER AIR EQUALIZER & CHAIN STYLE WD HITCH 12,000 lbs. GTW / 1,200 lbs. TW

SH-7002/SH-7500	2" SHANK - 5" RISE 2" DROP
SH-7002-10/SH-7500	2" SHANK - 5" RISE 4" DROP
SH-7025/SH-7500	2-1/2" SHANK - 5" RISE 2" DROP
SH-7025-10/SH-7500	2-1/2" SHANK - 5" RISE 4" DROP
SH-7003/SH-7500	3" SHANK - 5" RISE 4" DROP

WANT SWAY CONTROL? ADD PART# SH-1001 (SHOCKER FRICTION SWAY ARMS)



GOOSENECK HITCHES



**NOW FEATURING OUR PATENT PENDING
MULTI-FIT GOOSENECK ROUND STEM!**

**•WORKS ON 100MM & 4" ROUND STEMS WITH STRAIGHT
OR ANGLED PIN HOLES**

•NO MORE GUESS WORK WHEN FITTING YOUR TRAILER

- ✓ **ADJUSTABLE FOR TOW WEIGHT**
- ✓ **LESS STRESS ON ANIMALS**
- ✓ **ELIMINATES BUCKING & CHUCKING**
- ✓ **REDUCES BREAKAGE**

Shocker 30K Gooseneck Surge[®] Air Hitch & Coupler

 Install Time: 5 minutes



 11,370,257 B1 & D898,628

 HOT SELLERS

-  **ADJUSTABLE FOR TOW WEIGHT**
 **REDUCES STRESS, WEAR, TEAR & BREAKAGE**
 **REDUCES STRESS ON PASSENGERS & ANIMALS**



30K GOOSENECK SURGE[®] AIR HITCH & SHIFT LOCK[®] COUPLER 30,000 lbs. GTW / 7,000 lbs. TW



SH-RND-SL	ROUND MULTI-FIT STEM - FITS 4" OR 100MM	 
SH-SQ-STR-SL	SQUARE MULTI-FIT STEM - FITS 4" OR 100MM	
SH-4RND-BLK-SL	4" ROUND STEM BLANK - NO PIN HOLES	
100SQ-TC-SL	TOP CRANK STEM - FITS 4" OR 100MM	
35SQ-BLK-SL	3-1/2" SQUARE STEM BLANK - NO PIN HOLES	
45SQ-STR-SL	4-1/2" SQUARE STEM	



- SHIFT LOCK[®] CAPTURES BOTH SIDES OF THE BALL FOR ULTIMATE SECURITY
- PATENT PENDING MULTI-FIT FITS 4" OR 100MM ROUND STEMS WITH STRAIGHT OR ANGLED HOLES



30K GOOSENECK SURGE[®] AIR HITCH & DEMCO COUPLER 30,000 lbs. GTW / 6,000 lbs. TW

SH-RND-DEM	ROUND MULTI-FIT STEM - FITS 4" OR 100MM	 
SH-SQ-STR-DEM	SQUARE MULTI-FIT STEM - FITS 4" OR 100MM	
SH-4RND-BLK-DEM	4" ROUND STEM BLANK - NO PIN HOLES	
SH-100SQ-TC-DEM	TOP CRANK STEM - FITS 4" OR 100MM	
SH-35SQ-BLK-DEM	3-1/2" SQUARE STEM BLANK - NO PIN HOLES	
SH-45SQ-STR-DEM	4-1/2" SQUARE STEM	



- FAST, QUICK, & EASY TO USE AUTO LATCHING COUPLER
- PATENT PENDING MULTI-FIT FITS 4" OR 100MM ROUND STEMS WITH STRAIGHT OR ANGLED HOLES

Shocker 30K Gooseneck Surge® Air Hitch & Offset Coupler

🔧 **Install Time: 5 minutes**

📄 **11,370,257 B1 & D898,628**

🔥 **HOT SELLERS**

✅ **ADJUSTABLE FOR TOW WEIGHT** ✅ **REDUCES STRESS, WEAR, TEAR & BREAKAGE** ✅ **REDUCES STRESS ON PASSENGERS & ANIMALS**

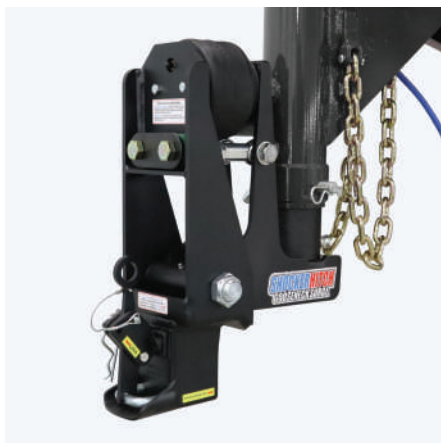

30K GOOSENECK SURGE® AIR HITCH & OFFSET SHIFT LOCK® COUPLER **30,000 lbs. GTW / 7,000 lbs. TW**

SH-RND-SL-9	ROUND MULTI-FIT STEM - FITS 4" OR 100MM	🔥 PATENT PENDING
SH-SQ-STR-SL-9	SQUARE MULTI-FIT STEM - FITS 4" OR 100MM	🔥
4RND-BLK-SL-9	4" ROUND STEM BLANK - NO PIN HOLES	
45SQ-STR-SL-9	4-1/2" SQUARE STEM	

•SHIFT LOCK® CAPTURES BOTH SIDES OF THE BALL FOR ULTIMATE SECURITY
•PATENT PENDING MULTI-FIT FITS 4" OR 100MM ROUND STEMS WITH STRAIGHT OR ANGLED HOLES

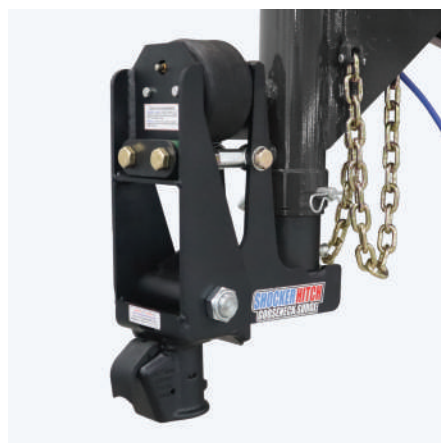

30K GOOSENECK SURGE® AIR HITCH & OFFSET DEMCO COUPLER **30,000 lbs. GTW / 6,000 lbs. TW**

SH-RND-DEM-9	ROUND MULTI-FIT STEM - FITS 4" OR 100MM	🔥 PATENT PENDING
SH-SH-SQ-STR-DEM-9	SQUARE MULTI-FIT STEM - FITS 4" OR 100MM	🔥
SH-4RND-BLK-DEM-9	4" ROUND STEM BLANK - NO PIN HOLES	
SH-45SQ-STR-DEM-9	4-1/2" SQUARE STEM	

•FAST, QUICK, & EASY TO USE AUTO LATCHING COUPLER
•PATENT PENDING MULTI-FIT FITS 4" OR 100MM ROUND STEMS WITH STRAIGHT OR ANGLED HOLES



Speciality Gooseneck Surge[®] Air Hitches



 Install Time: 5 minutes

 11,370,257 B1 & D898,628

 HOT SELLERS

-  ADJUSTABLE FOR TOW WEIGHT
-  REDUCES STRESS, WEAR, TEAR & BREAKAGE
-  REDUCES STRESS ON PASSENGERS & ANIMALS



40K GOOSENECK SURGE[®] AIR HITCH & SHIFT LOCK[®] COUPLER 40,000 lbs. GTW / 8,000 lbs. TW

SH-SQ-STR-SL40	SQUARE MULTI-FIT STEM - FITS 4" OR 100MM
SH-45SQ-STR-SL40	4-1/2" SQUARE STEM
SH-45SQ-BLK-SL40-DC	4-1/2" SQUARE STEM - DIAMOND C BOLTED

**SHIFT LOCK[®] CAPTURES BOTH SIDES OF THE BALL FOR ULTIMATE SECURITY*



30K GOOSENECK SURGE[®] AIR HITCH & KING PIN 30,000 lbs. GTW / 7,000 lbs. TW

SH-RND-KP	ROUND MULTI-FIT STEM - FITS 4" OR 100MM
SH-SH-SQ-STR-KP	SQUARE MULTI-FIT STEM - FITS 4" OR 100MM
SH-4RND-BLK-KP	4" ROUND STEM BLANK - NO PIN HOLES
SH-45SQ-STR-KP	4-1/2" SQUARE STEM

**PATENT PENDING MULTI-FIT FITS 4" OR 100MM ROUND STEMS WITH STRAIGHT OR ANGLED HOLES*

PATENT PENDING





Gooseneck Couplers



SHIFT LOCK® GOOSENECK STEM BLACK - 2-5/16" BALL **30,000 lbs. GTW / 6,000 lbs. TW**

•Standard stems (see more sizes online)

SL-SQ-STR	SQUARE MULTI-FIT STEM - FITS 4" OR 100MM
SL-4RND-BLK	4" ROUND BLANK STEM - NO PIN HOLES
SL-4RND-STR	4" ROUND STEM - STRAIGHT PIN HOLES
SL-4RND-ANG	4" ROUND STEM - ANGLED PIN HOLES
SL-100RND-STR	100MM ROUND STEM - STRAIGHT PIN HOLES
SL-100RND-ANG	100MM ROUND STEM - ANGLED PIN HOLES

•Offset stems (see more sizes online)

SL-9-SQ-STR	SQUARE MULTI-FIT STEM - FITS 4" OR 100MM
SL-9-4RND-BLK	4" ROUND BLANK STEM - NO PIN HOLES
SL-9-4RND-STR	4" ROUND STEM - STRAIGHT PIN HOLES
SL-9-4RND-ANG	4" ROUND STEM - ANGLED PIN HOLES
SL-9-100RND-STR	100MM ROUND STEM - STRAIGHT PIN HOLES
SL-9-100RND-ANG	100MM ROUND STEM - ANGLED PIN HOLES



SHIFT LOCK® GOOSENECK STEM RED - 2-5/16" BALL **30,000 lbs. GTW / 6,000 lbs. TW**

•Standard stems (see more sizes online)

SL-SQ-STR-RED	SQUARE MULTI-FIT STEM - FITS 4" OR 100MM
SL-4RND-BLK-RED	4" ROUND BLANK STEM - NO PIN HOLES
SL-35SQ-BLK-RED	3-1/2" SQUARE BLANK STEM - NO PIN HOLES
SL-45SQ-STR-RED	4-1/2" ROUND STEM - STRAIGHT PIN HOLES

•Offset stems (see more sizes online)

SL-9-SQ-STR-RED	SQUARE MULTI-FIT STEM - FITS 4" OR 100MM
SL-9-4RND-BLK-RED	4" ROUND BLANK STEM - NO PIN HOLES
SL-9-35SQ-BLK-RED	3-1/2" SQUARE BLANK STEM - NO PIN HOLES
SL-9-45SQ-STR-RED	4-1/2" ROUND STEM - STRAIGHT PIN HOLES



SHIFT LOCK® GOOSENECK STEM RAW - 2-5/16" BALL **30,000 lbs. GTW / 6,000 lbs. TW**

•Standard stems (see more sizes online)

SL-SQ-STR-RAW	SQUARE MULTI-FIT STEM - FITS 4" OR 100MM
SL-4RND-BLK-RAW	4" BLANK STEM - NO PIN HOLES
SL-4RND-STR-RAW	4" ROUND STEM - STRAIGHT PIN HOLES
SL-4RND-ANG-RAW	4" ROUND STEM - ANGLED PIN HOLES
SL-100RND-STR-RAW	100MM ROUND STEM - STRAIGHT PIN HOLES
SL-100RND-ANG-RAW	100MM ROUND STEM - ANGLED PIN HOLES

•Offset stems (see more sizes online)

SL-9-SQ-STR-RAW	SQUARE MULTI-FIT STEM - FITS 4" OR 100MM
SL-9-4RND-BLK-RAW	4" BLANK STEM - NO PIN HOLES
SL-9-4RND-STR-RAW	4" ROUND STEM - STRAIGHT PIN HOLES
SL-9-4RND-ANG-RAW	4" ROUND STEM - ANGLED PIN HOLES
SL-9-100RND-STR-RAW	100MM ROUND STEM - STRAIGHT PIN HOLES
SL-9-100RND-ANG-RAW	100MM ROUND STEM - ANGLED PIN HOLES

Gooseneck Couplers



DEMCO GOOSENECK STEM BLACK - 2-5/16" BALL **30,000 lbs. GTW / 6,000 lbs. TW**

•Standard stems (see more sizes online)

DEM-SQ-STR	SQUARE MULTI-FIT STEM - FITS 4" OR 100MM
DEM-4RND-BLK	4" BLANK STEM - NO PIN HOLES
DEM-4RND-STR	4" ROUND STEM - STRAIGHT PIN HOLES
DEM-4RND-ANG	4" ROUND STEM - ANGLED PIN HOLES
DEM-100RND-STR	100MM ROUND STEM - STRAIGHT PIN HOLES
DEM-100RND-ANG	100MM ROUND STEM - ANGLED PIN HOLES

•Offset stems (see more sizes online)

DEM-9-SQ-STR	SQUARE MULTI-FIT STEM - FITS 4" OR 100MM
DEM-9-4RND-BLK	4" BLANK STEM - NO PIN HOLES
DEM-9-4RND-STR	4" ROUND STEM - STRAIGHT PIN HOLES
DEM-9-4RND-ANG	4" ROUND STEM - ANGLED PIN HOLES
DEM-9-100RND-STR	100MM ROUND STEM - STRAIGHT PIN HOLES
DEM-9-100RND-ANG	100MM ROUND STEM - ANGLED PIN HOLES



DEMCO GOOSENECK STEM RAW - 2-5/16" BALL **30,000 lbs. GTW / 6,000 lbs. TW**

•Standard stems (see more sizes online)

DEM-SQ-STR-RAW	SQUARE MULTI-FIT STEM - FITS 4" OR 100MM
DEM-4RND-BLK-RAW	4" BLANK STEM - NO PIN HOLES
DEM-4RND-STR-RAW	4" ROUND STEM - STRAIGHT PIN HOLES
DEM-9-4RND-ANG-RAW	4" ROUND STEM - ANGLED PIN HOLES
DEM-100RND-STR-RAW	100MM ROUND STEM - STRAIGHT PIN HOLES
DEM-100RND-ANG-RAW	100MM ROUND STEM - ANGLED PIN HOLES

•Offset stems (see more sizes online)

DEM-9-SQ-STR-RAW	SQUARE MULTI-FIT STEM - FITS 4" OR 100MM
DEM-9-4RND-BLK-RAW	4" BLANK STEM - NO PIN HOLES
DEM-9-4RND-STR-RAW	4" ROUND STEM - STRAIGHT PIN HOLES
DEM-9-4RND-ANG-RAW	4" ROUND STEM - ANGLED PIN HOLES
DEM-9-100RND-STR-RAW	100MM ROUND STEM - STRAIGHT PIN HOLES
DEM-9-100RND-ANG-RAW	100MM ROUND STEM - ANGLED PIN HOLES



SHIFT LOCK® GOOSENECK STEM - 3" BALL **40,000 lbs. GTW / 8,000 lbs. TW**

•Black finish

SL-SQ-STR-SL40	SQUARE MULTI-FIT STEM - FITS 4" OR 100MM
SL-45SQ-STR-SL40	4-1/2" SQUARE STEM - STRAIGHT PIN HOLES
SL-45SQ-BLK-SL40-DC	4-1/2" SQUARE STEM - DIAMOND C BOLTED

•Raw steel

SL-SQ-STR-SL40-RAW	SQUARE MULTI-FIT STEM - FITS 4" OR 100MM
SL-45SQ-STR-SL40-RAW	4-1/2" SQUARE STEM - STRAIGHT PIN HOLES
SL-45SQ-BLK-SL40-DC-RAW	4-1/2" SQUARE STEM - DIAMOND C BOLTED



Gooseneck Couplers



WALLACE FORGE GOOSENECK STEM - 3" BALL 40,000 lbs. GTW / 8,000 lbs. TW

•Black finish

WF-SQ-STR-WF40

SQUARE MULTI-FIT STEM - FITS 4" OR 100MM

WF-45SQ-STR-WF40

4-1/2" SQUARE STEM - STRAIGHT PIN HOLES

•Raw steel

WF-SQ-STR-WF40-RAW

SQUARE MULTI-FIT STEM - FITS 4" OR 100MM

WF-45SQ-STR-WF40-RAW

4-1/2" SQUARE STEM - STRAIGHT PIN HOLES



Gooseneck Outer Sleeves



SHOCKER GOOSENECK OUTER TUBE SQUARE SLEEVE FOR GOOSENECK STEMS

SH-GN4P

FITS 4" SQUARE STEMS

SH-GN45P

FITS 4-1/2" SQUARE STEMS

SH-GN45P-DC

FITS 4-1/2" SQUARE STEMS -
DIAMOND C TELECOUPLER

5TH WHEEL HITCHES



✓ **ADJUSTABLE FOR TOW WEIGHT**

✓ **SAVES YOUR INVESTMENTS**

✓ **ELIMINATES BUCKING & CHUCKING**

✓ **GET YOUR TRUCK BED BACK**

Quick Air® 5th Wheel to Gooseneck Kits



 **Install Time: 10 minutes**

 **11,370,257 B1 & D898,628**

 **HOT SELLERS**

-  **EASY ON YOU & PASSENGERS**
-  **REDUCES STRESS, WEAR, TEAR & BREAKAGE**
-  **SAVES & PROTECTS YOUR INVESTMENTS**



QUICK AIR® 5TH WHEEL TO GOOSENECK - SHIFT LOCK® 24,000 lbs. GTW / 6,000 lbs. TW

4RND-STR-SL-CA/SH-RVGC-4405

LIPPERT 1621, 0719, / RHINO BOX 

4RND-STR-SL-CA/SH-RVGC-4410

LIPPERT 1716, 1116, 0115 / FEBEX 503, 520, 530, 560 

4RND-STR-SL-CA/SH-RVGC-4415

LIPPERT TURNING POINT

SH-PBCK

5TH WHEEL TO GOOSENECK CHAIN KIT

•SHIFT LOCK® CAPTURES BOTH SIDES OF THE BALL FOR ULTIMATE SECURITY



QUICK AIR® 5TH WHEEL TO GOOSENECK - DEMCO 24,000 lbs. GTW / 6,000 lbs. TW

4RND-STR-DEM-CA/SH-RVGC-4405

LIPPERT 1621, 0719, / RHINO BOX 

4RND-STR-DEM-CA/SH-RVGC-4410

LIPPERT 1716, 1116, 0115 / FEBEX 503, 520, 530, 560 

4RND-STR-DEM-CA/SH-RVGC-4415

LIPPERT TURNING POINT

SH-PBCK

5TH WHEEL TO GOOSENECK CHAIN KIT

•FAST, QUICK, & EASY TO USE AUTO LATCHING COUPLER



5th Wheel to Gooseneck Conversion Kits

 **Install Time: 10 minutes**  **11,370,257 B1**  **HOT SELLERS**

-  **FAST INSTALLATION**
-  **GET YOUR TRUCK BED BACK**
-  **QUICK & EASY TO USE**



5TH WHEEL TO GOOSENECK - SHIFT LOCK® 24,000 lbs. GTW / 6,000 lbs. TW

SL-4RND-STR-CA/SH-RVGC-4405	LIPPERT 1621, 0719, / RHINO BOX	
SL-4RND-STR-CA/SH-RVGC-4410	LIPPERT 1716, 1116, 0115 / FEBEX 503, 520, 530, 560	
SL-4RND-STR-CA/SH-RVGC-4415	LIPPERT TURNING POINT	
SH-PBCK	5TH WHEEL TO GOOSENECK CHAIN KIT	

•SHIFT LOCK® CAPTURES BOTH SIDES OF THE BALL FOR ULTIMATE SECURITY



5TH WHEEL TO GOOSENECK - DEMCO 24,000 lbs. GTW / 6,000 lbs. TW

DEM-4RND-STR-CA/SH-RVGC-4405	LIPPERT 1621, 0719, / RHINO BOX	
DEM-4RND-STR-CA/SH-RVGC-4410	LIPPERT 1716, 1116, 0115 / FEBEX 503, 520, 530, 560	
DEM-4RND-STR-CA/SH-RVGC-4415	LIPPERT TURNING POINT	
SH-PBCK	5TH WHEEL TO GOOSENECK CHAIN KIT	

•FAST, QUICK, & EASY TO USE AUTO LATCHING COUPLER



Quick Air® 5th Wheel Air Ride Pin Box



🔧 Install Time: 10 minutes 📦 11,370,257 B1 & D898,628

- ✔️ ADJUSTABLE FOR TOW WEIGHT
- ✔️ REDUCES STRESS, WEAR, TEAR & BREAKAGE
- ✔️ SAVES & PROTECTS YOUR INVESTMENTS



QUICK AIR® 5TH WHEEL AIR RIDE PIN BOX
24,000 lbs. GTW / 6,000 lbs. TW

PATENT
PENDING

SH-800-KP

LIPPERT 1621, 0719, / RHINO BOX

SH-800-KP-SH-GPB-Plates

LIPPERT 1716, 1116, 0115 / FEBEX 503, 520, 530, 560



AIR RIDE SYSTEM SITS INSIDE PIN BOX



TONGUE MOUNTS



- ✓ **ADJUSTABLE FOR TOW WEIGHT**
- ✓ **ADDS LIFE TO YOUR TRAILER**
- ✓ **INSTANT AIR RIDE FOR TRAILERS**
- ✓ **REDUCES BREAKAGE**

Shocker Air Trailer Tongue Mounts



Install Time: 5 minutes **Designed to fit 3" wide couplers & pintle rings (see page 32)** **HOT SELLERS**

ADJUSTABLE FOR TOW WEIGHT **INSTANT AIR RIDE FOR TRAILERS** **ADDS LIFE TO YOUR TRAILER** **REDUCES BREAKAGE**



AIR TRAILER TONGUE MOUNT 14,000 lbs. GTW / 1,400 lbs. TW

SH-4000	VERTICAL CHANNEL MOUNT	
SH-4500	4-BOLT PLATE MOUNT	
SH-4000-W20012-B	VERTICAL CHANNEL w/ WALLACE COUPLER 2" BALL	
SH-4500-W20012-B	4-BOLT PLATE w/ WALLACE COUPLER 2" BALL	



HD AIR TRAILER TONGUE MOUNT 25,000 lbs. GTW / 3,500 lbs. TW

SH-HD4000	VERTICAL CHANNEL MOUNT	
SH-HD4500	4-BOLT PLATE MOUNT	
SH-HD4000-W25625-B	VERTICAL CHANNEL w/ HD WALLACE COUPLER - 2-5/16" BALL	
SH-HD4500-W25625-B	4-BOLT PLATE w/ HD WALLACE COUPLER - 2-5/16" BALL	
SH-HD4000-D14040-81-B	VERTICAL CHANNEL w/ DEMCO COUPLER - 2-5/16" BALL	
SH-HD4500-D14040-81-B	4-BOLT PLATE w/ DEMCO COUPLER - 2-5/16" BALL	

4-BOLT PLATE MOUNTING



VERTICAL CHANNEL MOUNTING



Trailer Mount Channels & More!

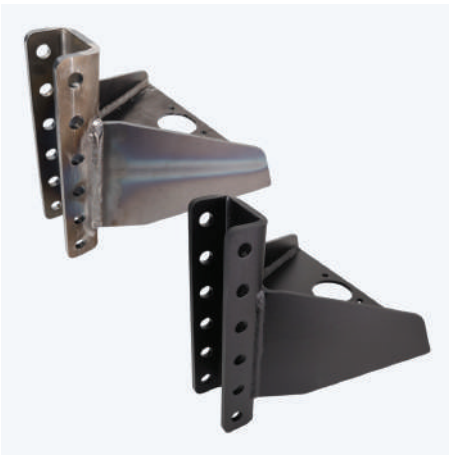

VERTICAL CHANNEL TONGUE ADAPTER FOR TRAILER A-FRAMES - UP TO 20,000 LBS. GTW

SH-410-C	COMPONENTS ONLY - RAW STEEL
SH-410-Spot	SPOT WELDED - RAW STEEL
SH-410-Welded	COMPLETELY WELDED - RAW STEEL
SH-410-BLK	COMPLETELY WELDED - BLACK

•Converts a typical 50° trailer tongue into a vertical channel



HD BOLT ON VERTICAL CHANNEL TONGUE ADAPTER FOR ALUMINUM TRAILER A-FRAMES - UP TO 20,000 LBS. GTW

SH-430-C	COMPONENTS ONLY - RAW STEEL
SH-430-Welded	COMPLETELY WELDED - RAW STEEL
SH-430-BLK	COMPLETELY WELDED - BLACK

•Bolt on design for 4", 5", 6" or 8" aluminum trailer A-frames
 •Converts a typical 50° trailer tongue into a vertical channel



SHOCKER CLAMP-ON SIDE MOUNT TRAILER JACK BRACKET KIT

SH-7020	ROUND JACK BRACKET KIT
SH-7030	SQUARE JACK BRACKET KIT



Trailer Couplers & Pintle Ring

DEMCO EZ-LATCH - 2-5/16"
21,000 lbs. GTW

SH-D14040-81-B



DEMCO METAL EZ-LATCH - 2-5/16"
21,000 lbs. GTW

SH-D15791-81-B



WALLACE FORGE - 2-5/16"
20,000 lbs. GTW

SH-W25620-B



WALLACE FORGE HD - 2-5/16"
25,000 lbs. GTW

SH-W25625-B



WALLACE FORGE - 2"
12,000 lbs. GTW

SH-W20012-B



SHOCKER PINTLE RING
20,000 lbs. GTW

SH-P20000-B



Auto Air Compressor Kit



SHOCKER AUTO AIR COMPRESSOR KIT **LICENSE PLATE MOUNT**

PATENT PENDING

SH-6000	NO AIR LINE
SH-6000-2	INCLUDES 2' AIR LINE
SH-6000-5	INCLUDES 5' AIR LINE
SH-6000-10	INCLUDES 10' AIR LINE
SH-6000-24	INCLUDES 24' AIR LINE

- Adjust hitch air pressure from the cab with a handheld remote
- Fits behind your rear license plate using factory mounting holes
- Save two air pressure presets for quick, one-touch adjustments
- Features a 12V compressor and dual-path controller

Skid Steer Trailer Mover

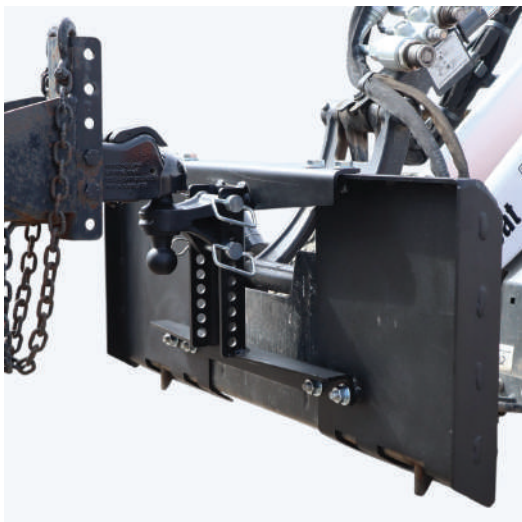

SKID STEER TRAILER MOVER ATTACHMENT **WORKS WITH QUICK ATTACH MOUNTS**

SH-S1000	NO ATTACHMENT
SH-S1000-SH-340BLK	w/BLACK COMBO BALL
SH-S1000-SH-360	w/CLEVIS PIN MOUNT
SH-S1000-SH-350	w/DRAW BAR MOUNT
SH-S1000-SH-333	w/CHANNEL PINTLE HOOK
SH-S1000-SH-405	w/2" RECEIVER HITCH MOUNT

- Quickly attaches to standard Melroe-style quick-attachments
- Features a 10-hole adjustable height channel
- Compatible with all Shocker attachments
- Built with heavy-duty American steel and a premium textured matte black finish



Hitch Locks



SHOCKER RECEIVER HITCH LOCKING PINS

SH-318	RECEIVER ONLY - UP TO 3"
SH-317	HITCH FRAME ONLY - BALL MOUNT
SH-317-318	1 RECEIVER - 1 BALL MOUNT
SH-317-2-318	1 RECEIVER - 2 BALL MOUNT

•Fits Shocker receiver hitches and standard truck receivers



SHOCKER SHIFT LOCK® COUPLER LOCK - PAD LOCK **FITS 2-5/16" & 3" SHIFT LOCK® COUPLERS**

SH-9000-Lock	FITS 2-5/16" & 3" SHIFT LOCK®
--------------	-------------------------------

- Specifically designed to lock Shocker Shift Lock® gooseneck couplers
 - Works with standard padlocks or disc-style locks (lock not included)
 - Built from high-strength steel with a textured matte black finish
- CAN WORK WITH SH-9500 SHOCKER DISC PUCK LOCK**



SHOCKER DEMCO COUPLER LOCK - PAD LOCK **FITS 2-5/16" DEMCO EZ-LATCH COUPLERS**

SH-9100	FITS 2-5/16" DEMCO EZ-LATCH
---------	-----------------------------

- Specifically designed to lock Demco EZ-Latch gooseneck couplers
 - Works with standard padlocks or disc-style locks (lock not included)
 - Built from high-strength steel with a textured matte black finish
- CAN WORK WITH SH-9500 SHOCKER DISC PUCK LOCK**



SHOCKER DISC PUCK LOCK **COMES WITH 2 KEYS**

SH-9500	COMES WITH 2 KEYS
---------	-------------------

•Works with SH-9000-Lock and SH-9100 pad lock style coupler locks

Replacement Parts



REPLACEMENT BUMP CUSHION ASSEMBLIES RECEIVER & TONGUE HITCHES

SH-265-2025	FOR 14K & 10K AIR RECEIVER HITCH
SH-HD265-2025	FOR 20K AIR RECEIVER HITCH
SH-IM265D-2025	FOR IMPACT RECEIVER HITCH
SH-266	FOR PRE-2020 AIR RECEIVER HITCH
SH-AE265D	FOR AIR EQUALIZER HITCH
SH-1170	FOR AIR TONGUE MOUNT



REPLACEMENT BUMP CUSHION ASSEMBLIES GOOSENECK HITCHES

SH-1070	FOR 30K GOOSENECK SURGE® HITCH
SH-1070HD	FOR 40K GOOSENECK SURGE® HITCH



AIR RIDE SYSTEM REPLACEMENT AIR BAGS RECEIVER, TONGUE, & GOOSENECK HITCHES

SH-202-SH-212	FITS 8K/10K/12K/14K AIR RECEIVER & EQUALIZER
SH-202-SH-212	FITS 10K/12K/14K AIR RECEIVER - HAS AIR LINE
SH-202-SH-90294	FITS EQUALIZER, 14K TONGUE, TRAIL FORCE & SPORT - HAS AIR VALVE
SH-203	FITS GOOSENECK AIR
SH-203-SH-90294	FITS GOOSENECK AIR - HAS AIR VALVE
SH-204	FITS 20K HD AIR RECEIVER & HD TONGUE MOUNT
SH-204-SH-214	FITS 20K HD AIR RECEIVER - HAS AIR LINE
SH-204-SH-684-4	FITS HD TONGUE MOUNT - HAS AIR VALVE
SH-205	FITS QUICK AIR 5TH WHEEL
SH-58103	FITS AIR RECEIVER (1B5-2) 2008 & OLDER

NEED SOMETHING MORE SPECIFIC? VISIT US ONLINE OR GIVE US A CALL!

 WWW.SHOCKERHITCH.COM

 (701)-707-2666

 2801 3RD AVE SW
JAMESTOWN, ND 58401

SCAN TO LEARN MORE



SHOCKER HITCH
AIR RIDE TOWING HITCHES

SAFER. SMOOTHER. EVERY MILE.